

Piezoelectric Sound Components



Piezoelectric Sounders External Drive SMD Type

Taking advantage of extensive acoustic and mechanical design technology and high performance ceramics, Murata has developed SMD piezoelectric sounders that suit the thin, high-density design of electronic equipment.

■ Features

1. Small, thin and lightweight
2. High sound pressure level and clear sound
3. Reflowable
4. Tape & Reel supply



PKLCS1212E2000-R1

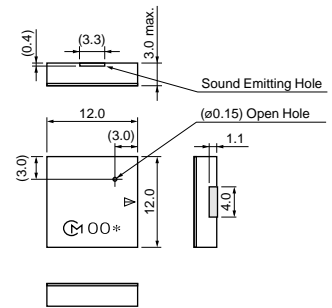

() : Ref. only
(in mm)
Tol. ±0.2



PKLCS1212E4001-R1

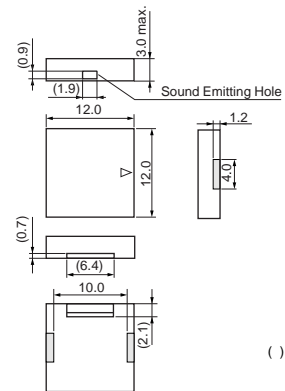

() : Ref. only
(in mm)
Tol. ±0.2

Part Number	Sound Pressure Level (dB)	Operating Voltage Range (Vp-p)	Operating Temp. Range (°C)	Storage Temp. Range (°C)	Use
PKLCS1212E2000-R1	70 min.[3Vp-p,2kHz,square wave,10cm]	25 max.	-20 to +70	-30 to +80	For consumer electronics
PKLCS1212E20A0-R1	70 min.[3Vp-p,2kHz,square wave,10cm]	25 max.	-40 to +85	-40 to +85	For automotive electronics
PKLCS1212E4001-R1	75 min.[3Vp-p,4kHz,square wave,10cm]	25 max.	-20 to +70	-30 to +80	For consumer electronics
PKLCS1212E40A1-R1	75 min.[3Vp-p,4kHz,square wave,10cm]	25 max.	-40 to +85	-40 to +85	For automotive electronics

■ Standard Land Pattern Dimensions

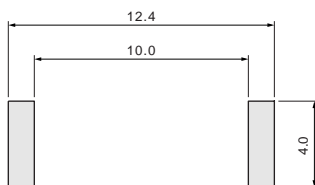

(in mm)

■ Freq. Response (Square Wave 3Vp-p, 10cm)

PKLCS1212E2000-R1

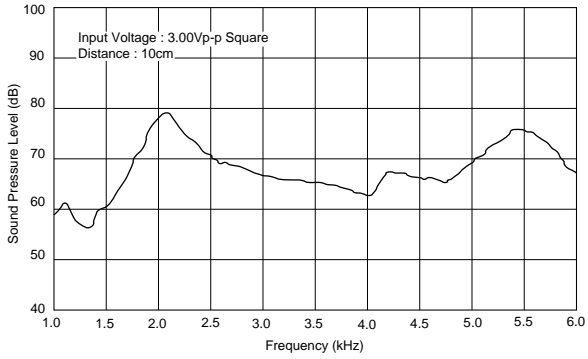

PKLCS1212E4001-R1

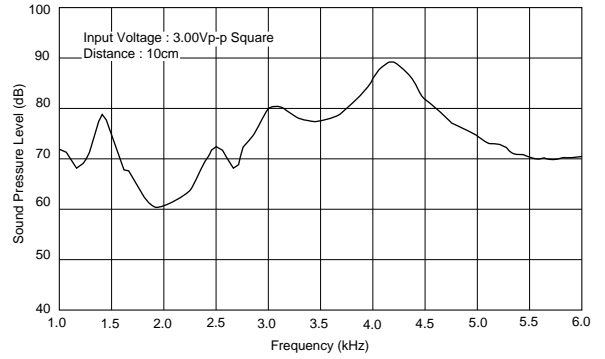

■ Taping Dimension

Dimensions of Carrier Tape

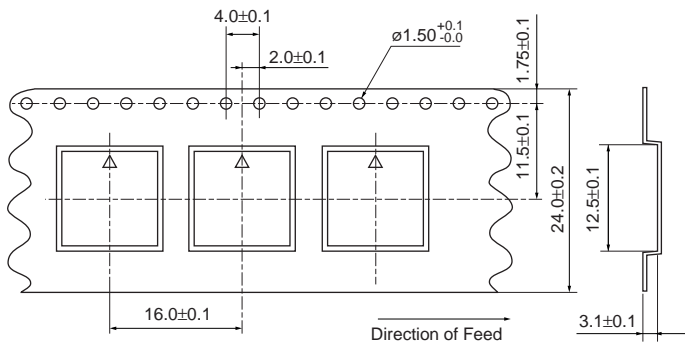

Dimensions of Reel

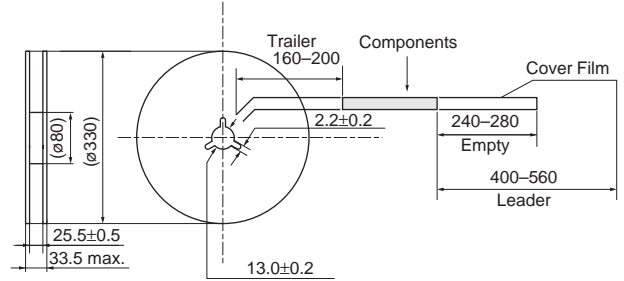

The cover film peel strength force 0.1-0.7N
 The cover film peel speed 300mm/min.

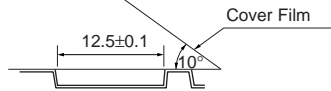

(in mm)

5

Piezoelectric Sounders (External Drive) Circuit/Notice

■ Circuit

The following are examples of externally driven circuits.

- (1) Unstable multi-vibrator using Tr.
- (2) Circuits using inverters or NAND gates.

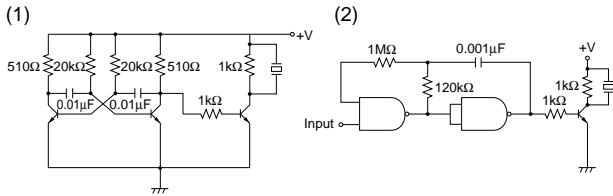

■ Notice (Soldering and Mounting)

Washing of the component is not acceptable, because it is not sealed.

■ Notice (Handling)

1. The component may be damaged if mechanical stress exceeding specifications is applied.
2. Take care to protect operating circuit from surge voltage resulting from excessive force, falling, shock or temperature change.
3. If DC voltage is applied to the component, silver migration may occur. Please pay full attention to avoid subjecting the component to DC voltage for long periods.
4. The resistor should be used as shown in Fig. A.
 A suitable resistance value should be chosen, preferably 1kΩ to 2kΩ. Instead of this measure, a diode may also be applied as shown in Fig. B.

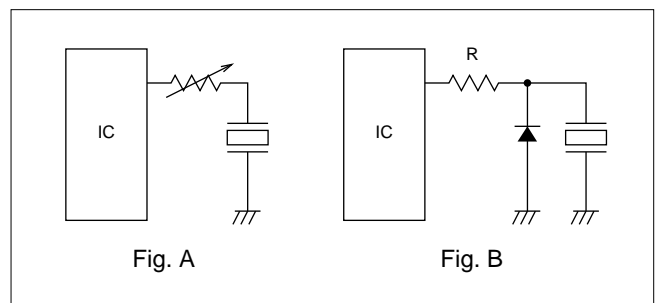

5. Avoid excessive pulling of lead wire because wire may break or soldering point may come off.